

Forming pliers

138 mm

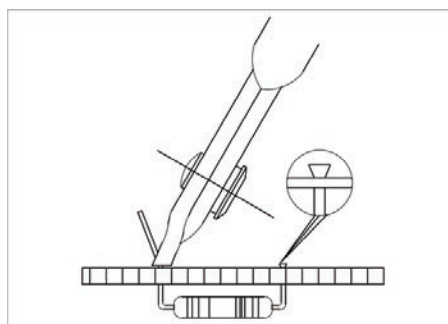

SPECIFICATION:

Variants

ESD

Cross-section of jaws

Special shape

Length

138 mm

Art. Nr.

RND 550-00067